

DISTRIBUTORI OLEODINAMICI DIRECTIONAL CONTROL VALVES

DISTRIBUTORI OLEODINAMICI DIRECTIONAL CONTROL VALVES

➔	GARATTERISTICHE GENERALI GENERAL FEATURES	pag. 3
➔	CONDIZIONI DI IMPIEGO CONDITIONS OF USE	pag. 4
➔	LT 30 1-2-3-4 LEVE/LEVERS	pag. 5
➔	LT 25 1-2-3 LEVE/LEVERS	pag. 7
➔	LT 25 4-5-6 LEVE/LEVERS	pag. 9
➔	LT 25 1-2-3-4-5-6 LEVE/LEVERS +COM. ELETT.+EM	pag. 11
➔	LT 70 1-2-3 LEVE/LEVERS	pag. 13
➔	LT 60 1-2-3 LEVE/LEVERS	pag. 15
➔	LT 50 1-2-3-4-5-6-7-8-9 LEVE/LEVERS	pag. 17
➔	LT 40 1-2-3-4-5-6-7-8-9-10 LEVE/LEVERS	pag. 19
➔	LT 120 1-2-3-4-5-6-7-8 LEVE/LEVERS	pag. 21
➔	CURSORI PILOT SHAFT	pag. 23
➔	TIPI AZIONAMENTO OPERATION TYPES	pag. 24

Алматы (7273)495-231
Ангарск (3955)60-70-56
Архангельск (8182)63-90-72
Астрахань (8512)99-46-04
Барнаул (3852)73-04-60
Белгород (4722)40-23-64
Благовещенск (4162)22-76-07
Брянск (4832)59-03-52
Владивосток (423)249-28-31
Владикавказ (8672)28-90-48
Владимир (4922)49-43-18
Волгоград (844)278-03-48
Вологда (8172)26-41-59
Воронеж (473)204-51-73
Екатеринбург (343)384-55-89

Россия +7(495)268-04-70

Иваново (4932)77-34-06
Ижевск (3412)26-03-58
Иркутск (395)279-98-46
Казань (843)206-01-48
Калининград (4012)72-03-81
Калуга (4842)92-23-67
Кемерово (3842)65-04-62
Киров (8332)68-02-04
Коломна (4966)23-41-49
Кострома (4942)77-07-48
Краснодар (861)203-40-90
Красноярск (391)204-63-61
Курск (4712)77-13-04
Курган (3522)50-90-47
Липецк (4742)52-20-81

Магнитогорск (3519)55-03-13
Москва (495)268-04-70
Мурманск (8152)59-64-93
Набережные Челны (8552)20-53-41
Нижний Новгород (831)429-08-12
Новокузнецк (3843)20-46-81
Новыйорск (3496)41-32-12
Новосибирск (383)227-86-73
Омск (3812)21-46-40
Орел (4862)44-53-42
Оренбург (3532)37-68-04
Пенза (8412)22-31-16
Петрозаводск (8142)55-98-37
Псков (812)59-10-37
Пермь (342)205-81-47

Казахстан +7(7172)727-132

Ростов-на-Дону (863)308-18-15
Рязань (4912)46-61-64
Самара (846)206-03-16
Санкт-Петербург (812)309-46-40
Саратов (845)249-38-78
Севастополь (8692)22-31-93
Саранск (8342)22-96-24
Симферополь (3652)67-13-56
Смоленск (4812)29-41-54
Орел (862)225-72-31
Ставрополь (8652)20-65-13
Сургут (3462)77-98-35
Сыктывкар (8212)25-95-17
Тамбов (4752)50-40-97
Тверь (4822)63-31-35

Киргизия +996(312)96-26-47

Тольятти (8482)63-91-07
Томск (3822)98-41-53
Тула (4872)33-79-87
Тюмень (3452)66-21-18
Ульяновск (8422)24-23-59
Улан-Удэ (3012)59-97-51
Уфа (347)229-48-12
Хабаровск (4212)92-98-04
Чебоксары (8352)28-53-07
Челябинск (351)202-03-61
Череповец (8202)49-02-64
Чита (3022)38-34-83
Якутск (4112)23-90-97
Ярославль (4852)69-52-93

CARATTERISTICHE GENERALI GENERAL FEATURES

134001

DISTRIBUTORI MONOBLOCCO

Distributori per portate fino a 120 l/min e pressioni fino a 300 bar.

I corpi sono in ghisa ad alta resistenza. I cursori sono in acciaio al nichel cementati e temprati.

Ogni gruppo è normalmente corredato di valvola generale di massima pressione in entrata, e di valvola di non-ritorno.

L'alimentazione del distributore è standard a sinistra e, a richiesta, a destra.

La distribuzione è normalmente in parallelo, ma su alcuni modelli è disponibile anche in serie.

A richiesta sono disponibili valvole ausiliarie da flangiare sugli utilizzi (max. pressione, anti-urto, anti-cavitazione, di blocco pilotate e rigeneratrici) e valvole complementari.

Il comando cursore è normalmente manuale, a richiesta sono disponibili comandi pneumatici, elettro pneumatici, idraulici, elettro-idraulici, elettrici, con cavi flessibili.

DISTRIBUTORI COMPONENTI

Distributori ad elementi componibili per portate fino a 220 l/min e pressioni fino a 300 bar.

Gli elementi e le fiancate sono in ghisa ad alta resistenza. I cursori sono in acciaio al carbonio nichelati.

Ogni gruppo è corredato di valvola generale di massima pressione in entrata.

Ogni elemento è dotato di valvola di non ritorno ed è predisposto per il montaggio di valvole ausiliarie (anti-urto, max.pressione e anti-cavitazione). È possibile inoltre montare valvole di blocco pilotate flangiate sugli utilizzi.

L'alimentazione del distributore è standard a sinistra e, a richiesta, a destra. La distribuzione può essere in parallelo, serie e serie-parallelo.

Il comando cursore è normalmente manuale, a richiesta sono disponibili comandi pneumatici, idraulici, elettrici, elettroidraulici, con cavi flessibili.

Sono disponibili elementi intermedi speciali con valvola di max.pressione, valvola prioritaria, valvola di esclusione, divisori di portata con regolatore, collettori di scarico.

Il nostro Servizio Tecnico Commerciale è a completa disposizione per qualsiasi ulteriore chiarimento circa le applicazioni di questo prodotto.

SINGLE DIRECTIONAL CONTROL VALVES

Directional control valves for flows up to 120 l/min and pressures up to 300 bar.

The valve bodies are in high strength cast iron. The pilot shafts are in casehardened and tempered nickel steel.

Each unit is generally supplied with a maximum pressure valve at the inlet and a non-return valve.

The directional control valve is supplied with a left hand feed as standard; right hand feed can be supplied on request.

Distribution is generally in parallel, though series distribution is available on some models.

Auxiliary valves for flange fitting to the service ports (max. pressure, shockproof, anti-cavitation, piloted block valves and recovery valves) and supplementary valves are available on request.

Pilot shaft control is normally manual, though pneumatic, electro-pneumatic, hydraulic, electro-hydraulic and electric controlled levers with flexible cables are available on request.

MULTIPLE DIRECTIONAL CONTROL VALVES

Multiple directional control valves for flows up to 220 l/min and pressures up to 300 bar.

Bodies and side elements are in high strength cast iron. Control levers are in nickel plated carbon steel.

Each group is equipped with a main max. inlet pressure valve.

Each single unit is fitted with a non-return valve and is designed to accept auxiliary valves (shockproof, max. pressure and anti-cavitation). Piloted block valves with flange fitting to the service ports can also be mounted.

The directional control valve is supplied with a left hand feed as standard; right hand feed can be supplied on request.

Distribution can be parallel, series or series-parallel.

Pilot shaft control is normally manual, though pneumatic, hydraulic, electric and electro-hydraulic controlled levers with flexible cables are available on request.

Special intermediate elements are also available: max. pressure valve, priority valve, stop valves, flow distribution valves with regulator, tank outlet manifolds.

Our Technical Sales Department is available for any further clarification regarding the applications of this product.

Temperatura ambientale : da -40 a + 100 °C <i>Ambient temperature : from -40 to +100C</i>	Viscosità cinematica : da 10 a 500 mm ² /s <i>Kinematic viscosity : from 10 to 500 mm²/s</i>	
Fluido idraulico : consultare tabella <i>Hydraulic fluid : see table</i>	Contaminazione ammessa : 29/18 (ISO/DIS 4406) <i>Allowed contamination : 29/18 (ISO/DIS 4406)</i>	
FLUIDO - FLUID	GUARNIZIONI - GASKETS	
* NBR Elastomero in gomma nitrilica resistente ad oli minerali e grassi. ** FPM Elastomero fluorurato (VITON) resistente al calore ed agli altri agenti chimici. * <i>NBR Elastomer in mineral oil-resistant and grease-resistant nitrile rubber and mineral oli and grease.</i> ** <i>FPM Fluorinated heat-resistant and chemical resistant elastomer (VITON).</i>	NBR*	FPM**
		CAMPO DI TEMPERATURA DEL FLUIDO (°C) FLUID TEMPERATURE RANGE (°C)
Olio minerale HLP secondo DIN 51524 e 51525 <i>HLP mineral oil according to DIN 51524 and 51525</i>	●	- 20 + 80
Acqua con olio (emulsione con max. 20% di componenti infiammabili) <i>Water with oil (emulsion with max. 20% flammable components)</i>	●	- 20 + 100
Olio con acqua (emulsione con max. 60% di componenti infiammabili) <i>Oil with water (emulsion with max. 60% flammable components)</i>	●	+ 5 + 55
Soluzioni acquose a base di poliglicoli (40%-60% di acqua) <i>Polyglycol based aqueous solution (40%-60% water)</i>	●	+ 5 + 60
Etere dell'acido fosforico - <i>Phosphoric acid ether</i>		- 20 + 65
Idrocarburi clorurati (Benzene, Clorobenzene) <i>Chlorinated hydrocarbons</i>		- 15 +100
Miscele di etere e idrocarburi - <i>Mixture of ether and hydrocarbons</i>		

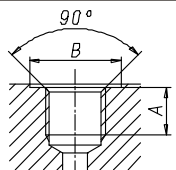
	Dimensioni Dimensions	BSP							
		G 1/8	G 1/4	G 3/8	G 1/2	G 3/4	G 1	G 1 1/4	G 1 1/2
	A	10	14	14	16	18	20	22	24
B (min.)	15	19	23	27	33	40	50	56	

	13400200095 Kit servocomando pneumatico LT 25/30 <i>Pneumatic servo control kit LT 25/30</i>
	13401600491 (12V) 13401600508 (24V) Kit ev. + raccordi per servocomando elettropneumatico 12V e 24V <i>Electropneumatic servo control kit 12V-24V</i>
	13400200353 Kit movimento scatto/scatto LT 25/30 <i>Lock/lock kit LT 25/30</i>
	13400200157 Tappo "H" doppio scarico <i>"H" double outlet plug</i>
	13400200344 Tappo "D" centro chiuso <i>"D" center closed plug</i>
	13400200139 Gruppo leva completo <i>Assembly lever group</i>
	13400200166 Leva nuda + pomello <i>Lever + knob</i>

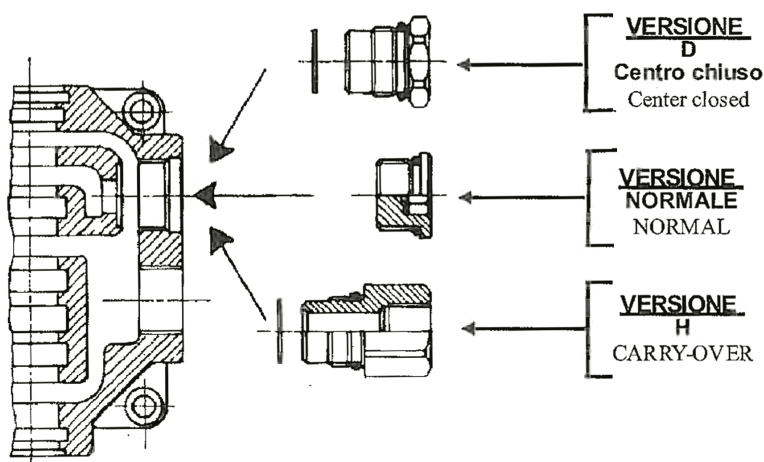
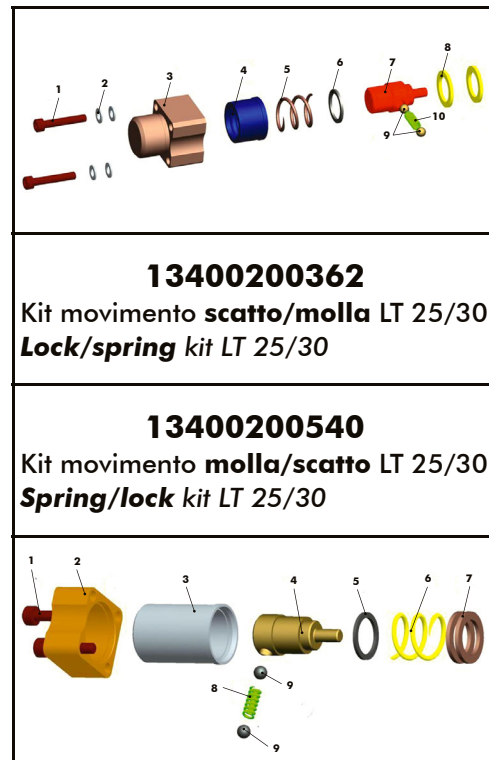

Codice / Code	Descrizione / Description	Versione / Version
13400200157	Tappo "Doppio scarico" LT 30 <i>Double outlet plug for LT 30</i>	H
13400200344	Tappo "Centro chiuso" LT 30 <i>Center closed plug for LT 30</i>	D

DISTRIBUTORI MONOBLOCCO "LT 25" A 1-2-3 LEVE

CODICE FAMIGLIA
FAMILY CODE

134003

DIRECTIONAL CONTROL VALVES "LT25" WITH 1-2-3 LEVERS

LT 25

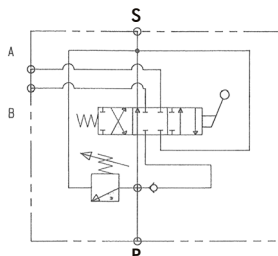

1 leva/lever

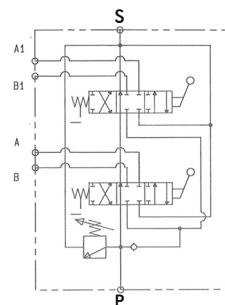

2 leve/levers

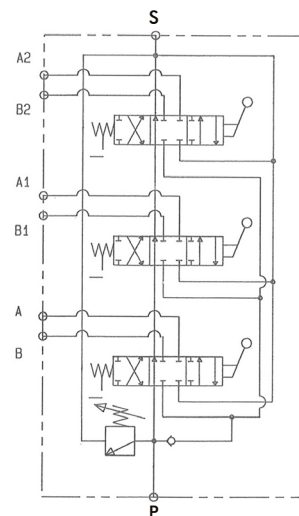



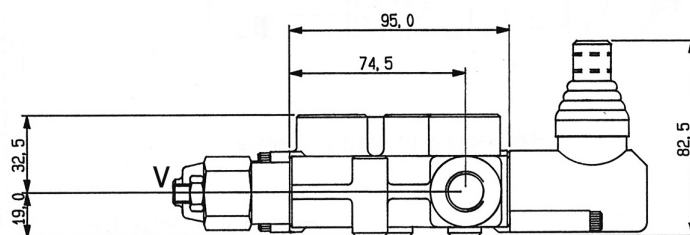
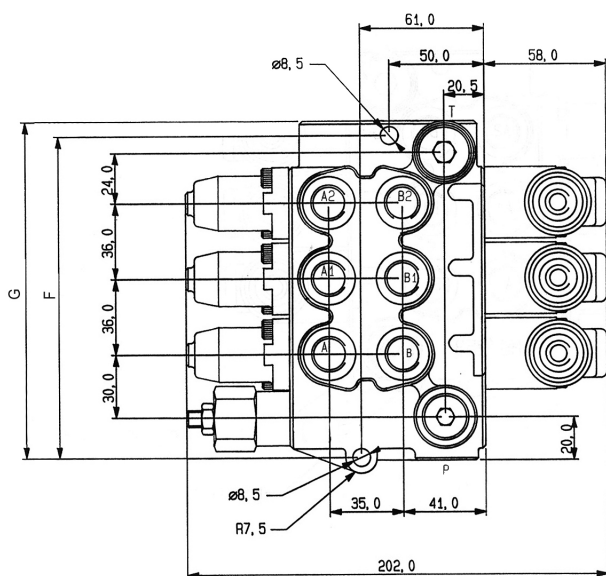



3 leve/levers

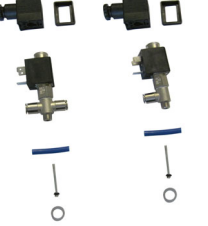

Simbolo / Symbol	Descrizione / Description
P	Pressione - Pressure
A-B	Utilizzi - Service ports
(S) T	Scarico - Tank outlet
V	Regolazione press. max. - Relief valve adjustamet
R	Tappo valvola controllo scarico Load control valve plug
+ MCR	Con microinterruttore - With microswitch

Tipo Type	Codice Code	Portata Flow l/min	Pressione Pressure bar	Dimensioni Dimension mm		Filettature disponibili Available thread		Peso Weight Kg
				F	G	P-A-B	T	
1 Leva - lever	13400300012	25	250	81	88	3/8" BSP	1/2" BSP	1,1
1 Leva+MCR - lever	13400310010							1,3
2 Leve - levers	13400300021			3,2				
2 Leve+MCR - levers	13400310029			3,4				
3 Leve - levers	13400300030			4,8				
3 Leve+MCR - levers	13400310038			5				

	13400200095 Kit servocomando pneumatico LT 25/30 <i>Pneumatic servo control kit LT 25/30</i>
	13401600491 (12V) 13401600508 (24V) Kit elettrovalvole + raccordi per servocomando elettropneumatico 12V e 24V <i>Electropneumatic servo control kit 12V-24V</i>
	13400200353 Kit movimento scatto/scatto LT 25/30 <i>Lock/lock kit LT 25/30</i>
	13400400011 Tappo "H" doppio scarico <i>"H" double outlet plug</i>
	13400400066 Tappo "D" centro chiuso <i>"D" center closed plug</i>
	13400400075 Gruppo leva completo <i>Assembly lever group</i>
	13400400164 Leva nuda + pomello <i>Lever + knob</i>

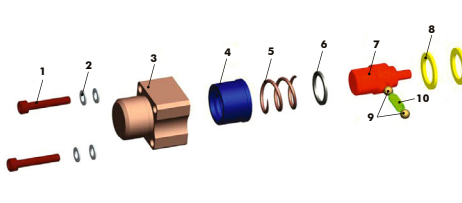
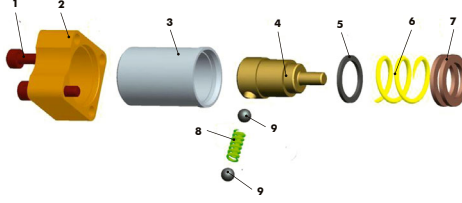



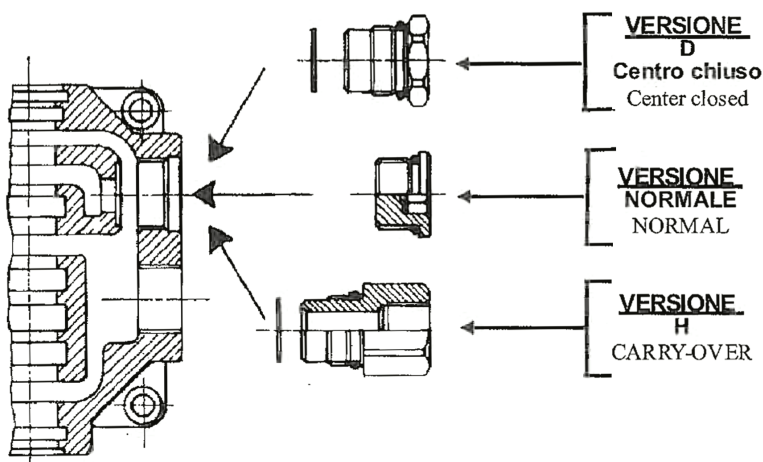

	13400200362 Kit movimento scatto/molla LT 25/30 <i>Lock/spring kit LT 25/30</i>
	13400200540 Kit movimento molla/scatto LT 25/30 <i>Spring/lock kit LT 25/30</i>

ALTRI ACCESSORI / OTHERS ACCESSORIES

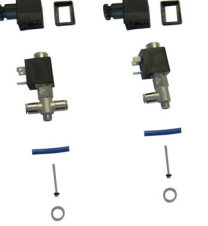
13400400137 Valvola di massima pressione / *Relief valve*



Codice / Code	Descrizione / Description	Versione / Version
13400400011	Tappo "Doppio scarico" LT 25 <i>Double outlet plug for LT 25</i>	H
13400400066	Tappo "Centro chiuso" LT 25 <i>Center closed plug for LT 25</i>	D

	13400200095 Kit servocomando pneumatico LT 25/30 <i>Pneumatic servo control kit LT 25/30</i>
	13401600491 (12V) 13401600508 (24V) Kit elettrovalvole + raccordi per servocomando elettropneumatico 12V e 24V <i>Electropneumatic servo control kit 12V-24V</i>
	13400200353 Kit movimento scatto/scatto LT 25/30 <i>Lock/lock kit LT 25/30</i>
	13400400011 Tappo "H" doppio scarico <i>"H" double outlet plug</i>
	13400400066 Tappo "D" centro chiuso <i>"D" center closed plug</i>
	13400400075 Gruppo leva completo <i>Assembly lever group</i>
	13400400164 Leva nuda + pomello <i>Lever + knob</i>

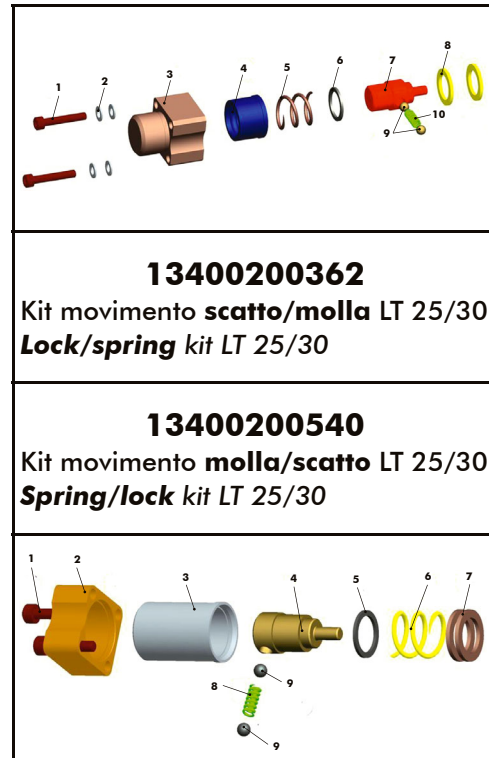

ALTRI ACCESSORI / OTHERS ACCESSORIES

13400400137 Valvola di massima pressione / *Relief valve*

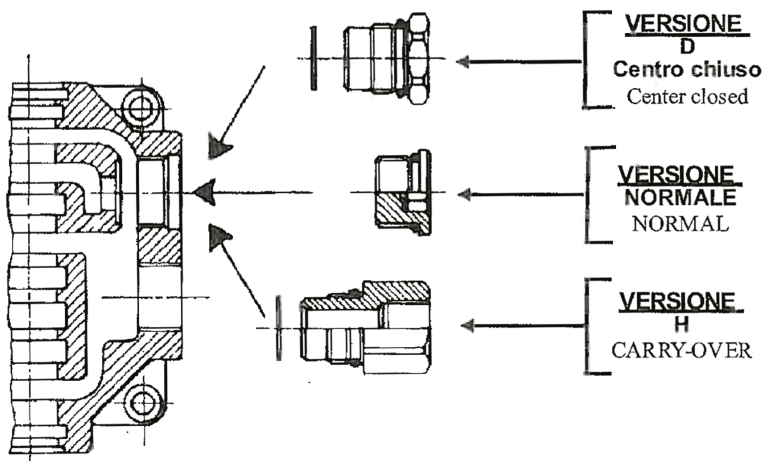

Codice / Code	Descrizione / Description	Versione / Version
13400400011	Tappo "Doppio scarico" LT 25 <i>Double outlet plug for LT 25</i>	H
13400400066	Tappo "Centro chiuso" LT 25 <i>Center closed plug for LT 25</i>	D

**DISTRIBUTORI MONOBLOCCO
"LT 25" A 1-2-3-4-5-6 LEVE**

**CODICE FAMIGLIA
FAMILY CODE**

134003

**DIRECTIONAL CONTROL VALVES
"LT25" WITH 1-2-3-4-5-6 LEVERS**

LT 25

**CON COMANDO ELETTRICO ED EMERGENZA MANUALE
WITH ELECTRIC CONTROL AND MANUAL EMERGENCY**

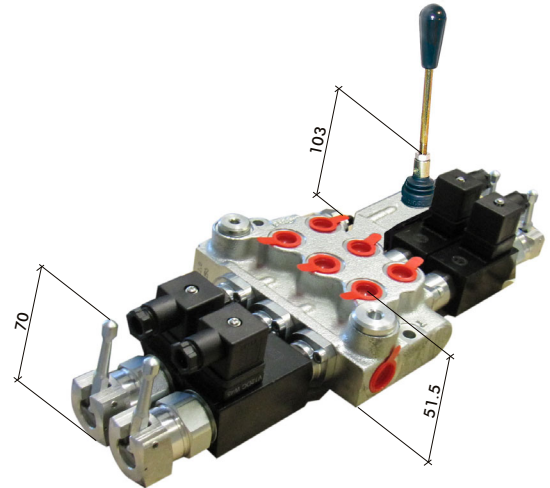
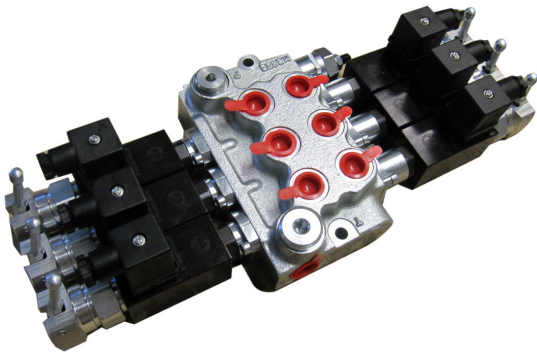



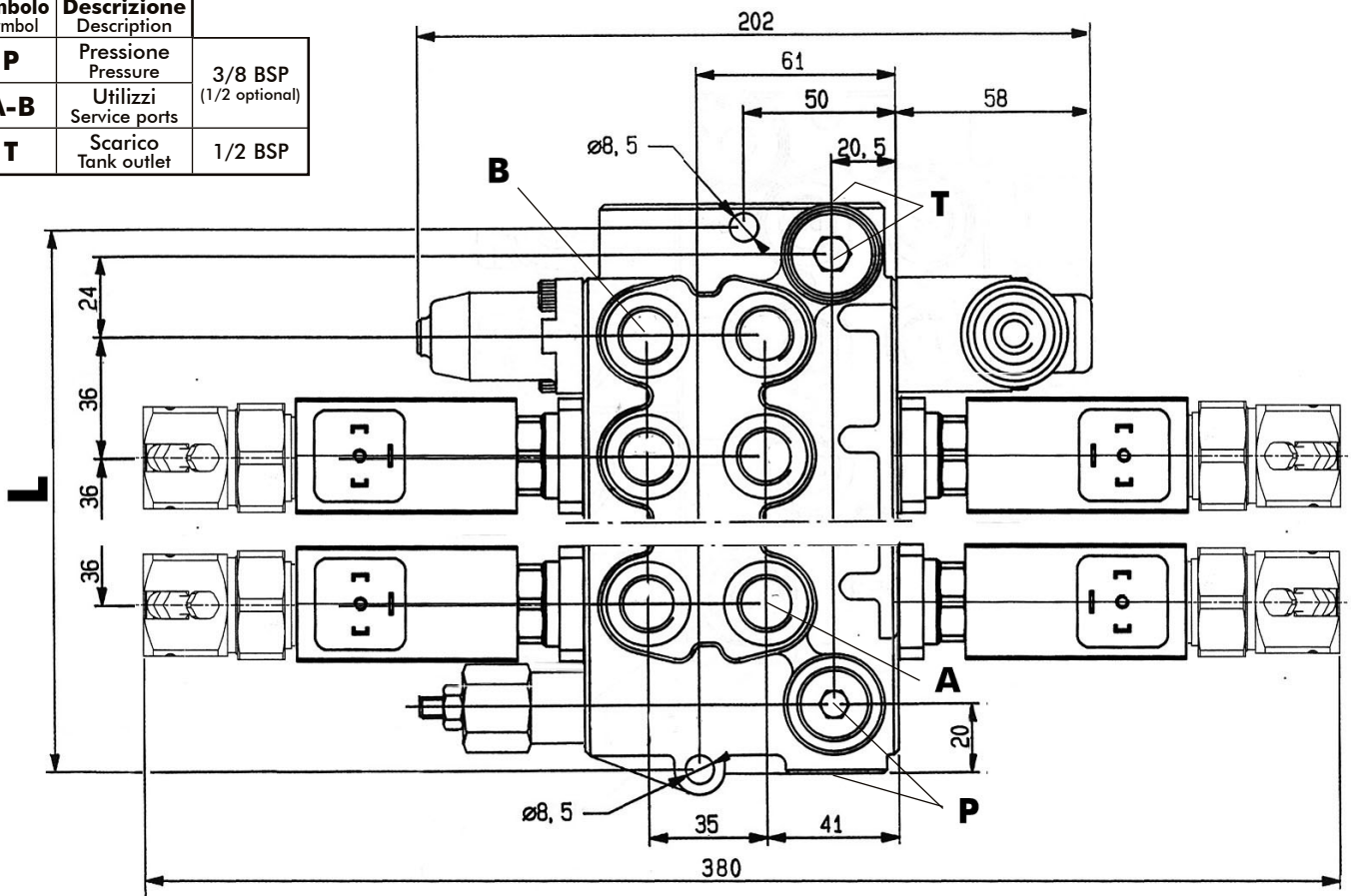

Simbolo Symbol	Descrizione Description	
P	Pressione Pressure	3/8 BSP
A-B	Utilizzi Service ports	(1/2 optional)
T	Scarico Tank outlet	1/2 BSP



Traduzione: 1 leva + 1 comando elettrico 12V + emergenza manuale
 Translation: 1 lever + 1 electric control 12V + manual emergency

Typo / Type	Codice / Code	Portata Flow l/min	Pressione Pressure bar	L mm	Peso Weight Kg
1 leva + 1 comando elettrico 12V + emergenza manuale	13400311126	25	250	81	3.6 Kg
1 leva + 1 comando elettrico 24V + emergenza manuale	13400311242				4.8 Kg
2 leve + 1 comando elettrico 12V + emergenza manuale	13400321124			117	6.1 Kg
2 leve + 1 comando elettrico 24V + emergenza manuale	13400321240				5.9 Kg
2 leve + 2 comandi elettrici 12V + emergenza manuale	13400322123			153	7.2 Kg
2 leve + 2 comandi elettrici 24V + emergenza manuale	13400322249				8.5 Kg
3 leve + 1 comando elettrico 12V + emergenza manuale	13400331122			189	7.1 Kg
3 leve + 1 comando elettrico 24V + emergenza manuale	13400331248				8.5 Kg
3 leve + 2 comandi elettrici 12V + emergenza manuale	13400332121			225	10 Kg
3 leve + 2 comandi elettrici 24V + emergenza manuale	13400332247				11.2 Kg
3 leve + 3 comandi elettrici 12V + emergenza manuale	13400333120			261	8.3 Kg
3 leve + 3 comandi elettrici 24V + emergenza manuale	13400333246				9.6 Kg
4 leve + 1 comando elettrico 12V + emergenza manuale	13400341120			225	10.8 Kg
4 leve + 1 comando elettrico 24V + emergenza manuale	13400341246				12 Kg
4 leve + 2 comandi elettrici 12V + emergenza manuale	13400342129			261	13.5 Kg
4 leve + 2 comandi elettrici 24V + emergenza manuale	13400342245				9.5 Kg
4 leve + 3 comandi elettrici 12V + emergenza manuale	13400343128			225	10.8 Kg
4 leve + 3 comandi elettrici 24V + emergenza manuale	13400343244				12.1 Kg
4 leve + 4 comandi elettrici 12V + emergenza manuale	13400344127			261	13.5 Kg
4 leve + 4 comandi elettrici 24V + emergenza manuale	13400344243				14.3 Kg
5 leve + 1 comando elettrico 12V + emergenza manuale	13400351128			225	16 Kg
5 leve + 1 comando elettrico 24V + emergenza manuale	13400351244				9.5 Kg
5 leve + 2 comandi elettrici 12V + emergenza manuale	13400352127			261	10.8 Kg
5 leve + 2 comandi elettrici 24V + emergenza manuale	13400352243				12.1 Kg
5 leve + 3 comandi elettrici 12V + emergenza manuale	13400353126			225	13.5 Kg
5 leve + 3 comandi elettrici 24V + emergenza manuale	13400353242				14.3 Kg
5 leve + 4 comandi elettrici 12V + emergenza manuale	13400354125			261	9.5 Kg
5 leve + 4 comandi elettrici 24V + emergenza manuale	13400354241				10.8 Kg
5 leve + 5 comandi elettrici 12V + emergenza manuale	13400355124			225	12.1 Kg
5 leve + 5 comandi elettrici 24V + emergenza manuale	13400355240				13.5 Kg
6 leve + 1 comando elettrico 12V + emergenza manuale	13400361126			261	14.3 Kg
6 leve + 1 comando elettrico 24V + emergenza manuale	13400361242				16 Kg
6 leve + 2 comandi elettrici 12V + emergenza manuale	13400362125			225	9.5 Kg
6 leve + 2 comandi elettrici 24V + emergenza manuale	13400362241				10.8 Kg
6 leve + 3 comandi elettrici 12V + emergenza manuale	13400363124			261	12.1 Kg
6 leve + 3 comandi elettrici 24V + emergenza manuale	13400363240				13.5 Kg
6 leve + 4 comandi elettrici 12V + emergenza manuale	13400364123			225	14.3 Kg
6 leve + 4 comandi elettrici 24V + emergenza manuale	13400364249				16 Kg
6 leve + 5 comandi elettrici 12V + emergenza manuale	13400365122			261	9.5 Kg
6 leve + 5 comandi elettrici 24V + emergenza manuale	13400365248				10.8 Kg
6 leve + 6 comandi elettrici 12V + emergenza manuale	13400366121	225	12.1 Kg		
6 leve + 6 comandi elettrici 24V + emergenza manuale	13400366247		13.5 Kg		

ACCESSORI / ACCESSORIES

	13400400100	Dispositivo emergenza a leva per 1 solenoide serv. elt. dir. Lever emergency
	13400400146	Tubo + flangia per AED lato v.max. Tube + flange v.max side
	13400400155	Tubo + flangia per AED lato leva Tube + flange lever side
	13400400226 13400400235	Bobina 12/24V qdr. per servocomando diretto Coil

DISTRIBUTORI MONOBLOCCO "LT 70" A 1-2-3 LEVE

CODICE FAMIGLIA
FAMILY CODE

134014

DIRECTIONAL CONTROL VALVES "LT70" WITH 1-2-3 LEVERS

LT 70

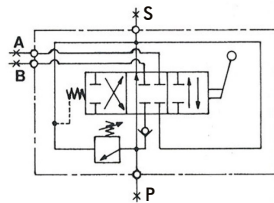
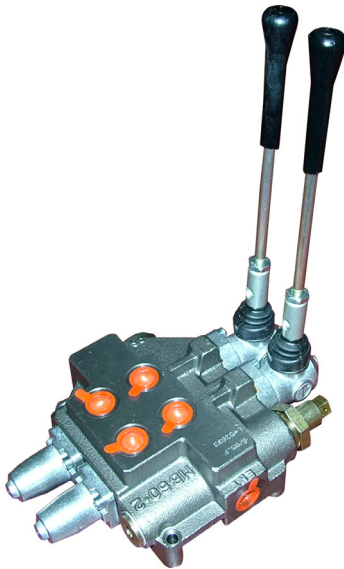

1 leva/lever

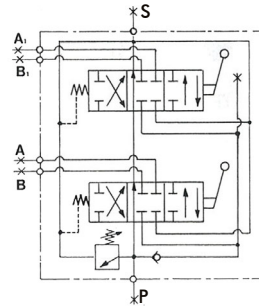

2 leve/levers

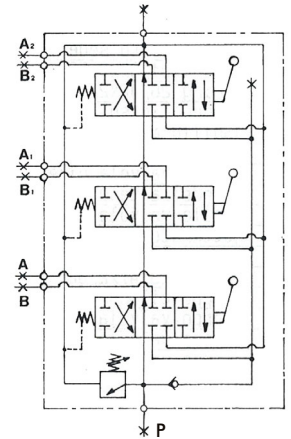



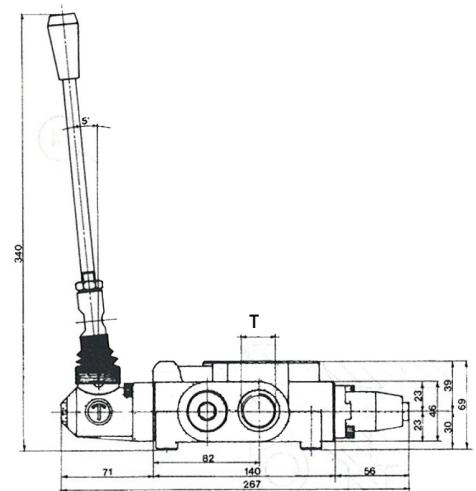
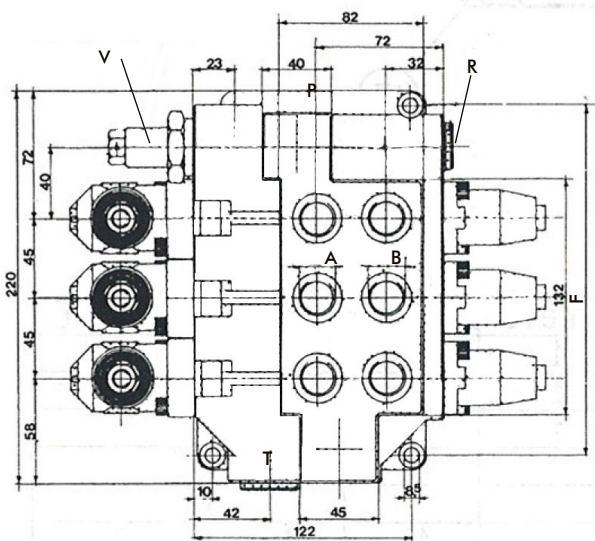



3 leve/levers

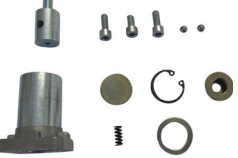
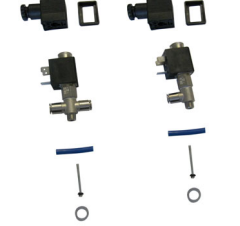
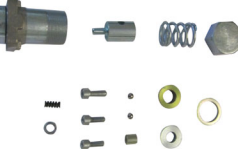

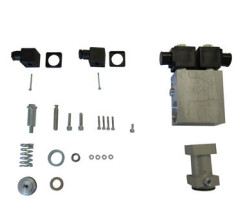
Simbolo / Symbol	Descrizione / Description
P	Pressione - Pressure
A-B	Utilizzi - Service ports
(S) T	Scarico - Tank outlet
V	Regolazione press. max. - Relief valve adjustmet
R	Tappo valvola controllo scarico Load control valve plug

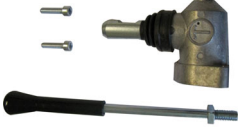
Tipo Type	Codice Code	Portata Flow l/min	Pressione Pressure bar	Dimensioni Dimension mm		Filettature disponibili Available thread		Peso Weight Kg
				F	G	P-A-B	T	
1 Leva - lever	13401400117	70	250	106	130	3/4" BSP	3/4" BSP	6,4
2 Leve - levers	13401400126			151	175			9,3
3 Leve - levers	13401400135			196	220			12,2

	13401600035 Kit servocomando pneumatico LT 60/120 <i>Pneumatic servo control kit LT 60/120</i>		13401600017 Kit movimento scatto/scatto LT 60/120 <i>Lock/lock kit LT 60/120</i>
	13401600491 (12V) 13401600508 (24V) Kit elettrovalvole + raccordi per servocomando elettropneumatico 12V e 24V <i>Electropneumatic servo control kit 12V-24V</i>		13401600179 Kit movimento scatto/molla LT 60/120 <i>Lock/spring kit LT 60/120</i>
	13401600099 (12V) 13401600106 (24V) Bobina 12V o 24V servocomando <i>Coil</i>		13401600062 Tappo "H" doppio scarico <i>"H" double outlet plug</i>
	13401600197 Kit servocomando elettroidraulico 24V <i>Electrohydraulic 24V kit</i>		13401600213 Tappo "D" centro chiuso <i>"D" center closed plug</i>
	13401600517 Kit servocomando elettroidraulico 12V <i>Electrohydraulic 12V kit</i>		13401600151 Gruppo leva completo <i>Assembly lever group</i>
	13401600204 Valvola contropressione scarico servocomando elettroidraulico <i>Back-pressure valves</i>		13401600446 Leva nuda + pomello <i>Lever + knob</i>

ALTRI ACCESSORI / OTHERS ACCESSORIES

- 13401600375** Valvola contropressione entrata per serv. elet. / *Back-pressure valves*
13401600384 Valvola di massima pressione / *Relief valve*
13401600393 Kit movimento 2 posizioni molla / *2 positions spring kit*

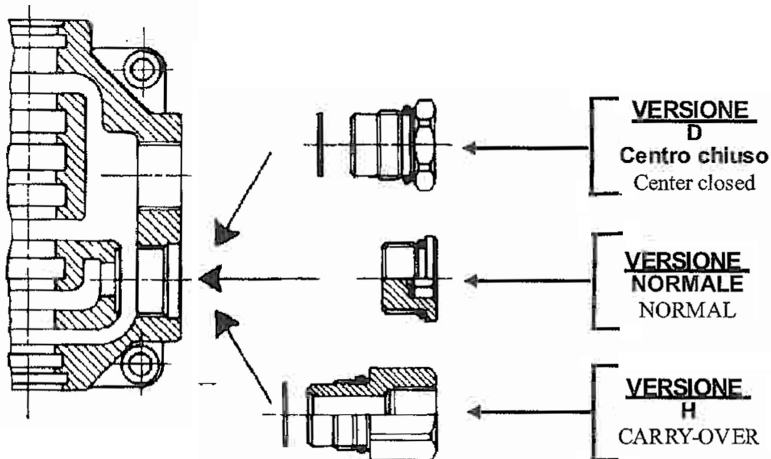

Codice / Code	Descrizione / Description	Versione Version
13401600062	Tappo "Doppio scarico" LT 60 <i>Double outlet plug for LT 60</i>	H
13401600213	Tappo "Centro chiuso" LT 60 <i>Center closed plug for LT 60</i>	D

DISTRIBUTORI MONOBLOCCO "LT 60" A 1-2-3 LEVE

CODICE FAMIGLIA
FAMILY CODE

134015

DIRECTIONAL CONTROL VALVES "LT60" WITH 1-2-3 LEVERS

LT 60

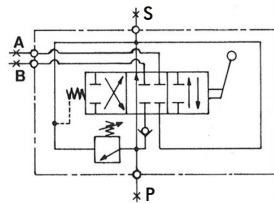
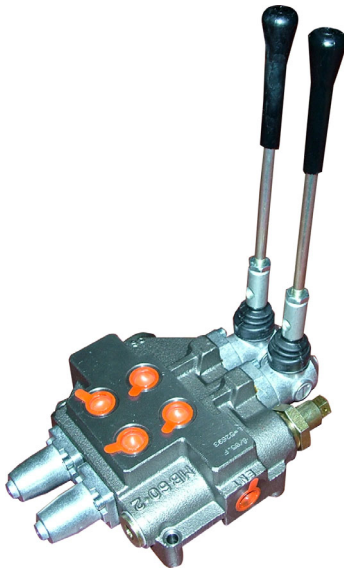

1 leva/lever

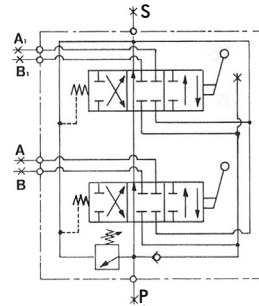

2 leve/levers

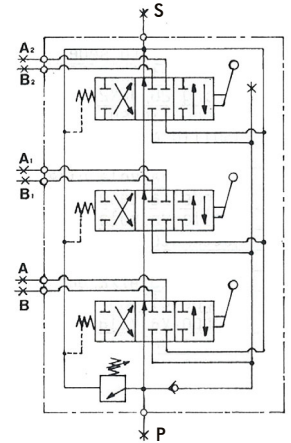



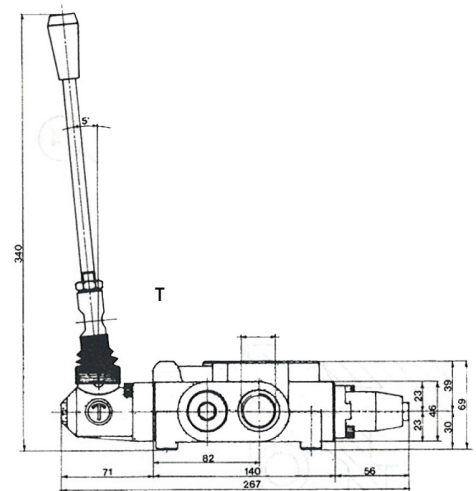
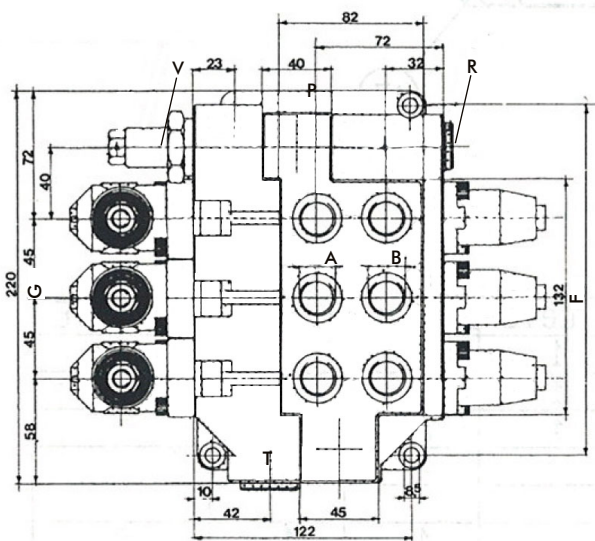



3 leve/levers

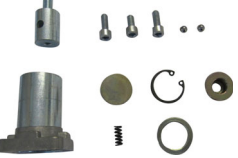
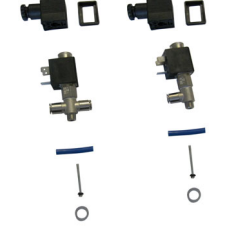
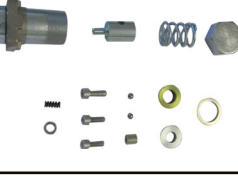

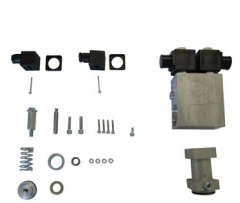
Simbolo / Symbol	Descrizione / Description
P	Pressione - Pressure
A-B	Utilizzi - Service ports
(S) T	Scarico - Tank outlet
V	Regolazione press. max. - Relief valve adjustmet
R	Tappo valvola controllo scarico Load control valve plug

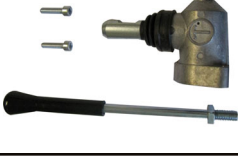
Tipo Type	Codice Code	Portata Flow l/min	Pressione Pressure bar	Dimensioni Dimension mm		Filettature disponibili Available thread		Peso Weight Kg
				F	G	P-A-B	T	
1 Leva - lever	13401500027	60	250	106	130	1/2" BSP	3/4" BSP	6,4
2 Leve - levers	13401500045			151	175			9,3
3 Leve - levers	13401500063			196	220			12,2

	13401600035 Kit servocomando pneumatico LT 60/120 <i>Pneumatic servo control kit LT 60/120</i>		13401600017 Kit movimento scatto/scatto LT 60/120 <i>Lock/lock kit LT 60/120</i>
	13401600491 (12V) 13401600508 (24V) Kit elettrovalvole + raccordi per servocomando elettropneumatico 12V e 24V <i>Electropneumatic servo control kit 12V-24V</i>		13401600179 Kit movimento scatto/molla LT 60/120 <i>Lock/spring kit LT 60/120</i>
	13401600099 (12V) 13401600106 (24V) Bobina 12V o 24V servocomando <i>Coil</i>		13401600062 Tappo "H" doppio scarico <i>"H" double outlet plug</i>
	13401600197 Kit servocomando elettroidraulico 24V <i>Electrohydraulic 24V kit</i>		13401600213 Tappo "D" centro chiuso <i>"D" center closed plug</i>
	13401600517 Kit servocomando elettroidraulico 12V <i>Electrohydraulic 12V kit</i>		13401600151 Gruppo leva completo <i>Assembly lever group</i>
	13401600204 Valvola contropressione scarico servocomando elettroidraulico <i>Back-pressure valves</i>		13401600446 Leva nuda + pomello <i>Lever + knob</i>

ALTRI ACCESSORI / OTHERS ACCESSORIES

- 13401600375** Valvola contropressione entrata per serv. elet. / *Back-pressure valves*
13401600384 Valvola di massima pressione / *Relief valve*
13401600393 Kit movimento 2 posizioni molla / *2 positions spring kit*

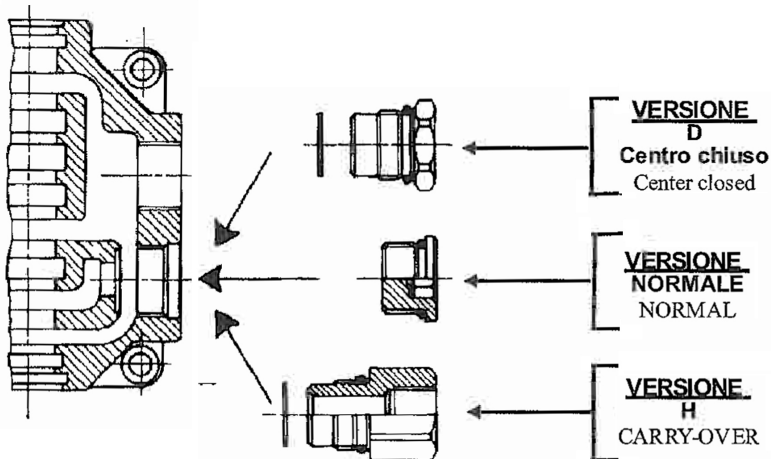

Codice / Code	Descrizione / Description	Versione Version
13401600062	Tappo "Doppio scarico" LT 60 <i>Double outlet plug for LT 60</i>	H
13401600213	Tappo "Centro chiuso" LT 60 <i>Center closed plug for LT 60</i>	D

DISTRIBUTORI COMPOSTO "LT 50" A 1-2-3-4-5-6-7-8-9 LEVE

CODICE FAMIGLIA
FAMILY CODE

134019

DIRECTIONAL CONTROL VALVES "LT 50" WITH 1-2-3-4-5-6-7-8-9 LEVERS

LT 50

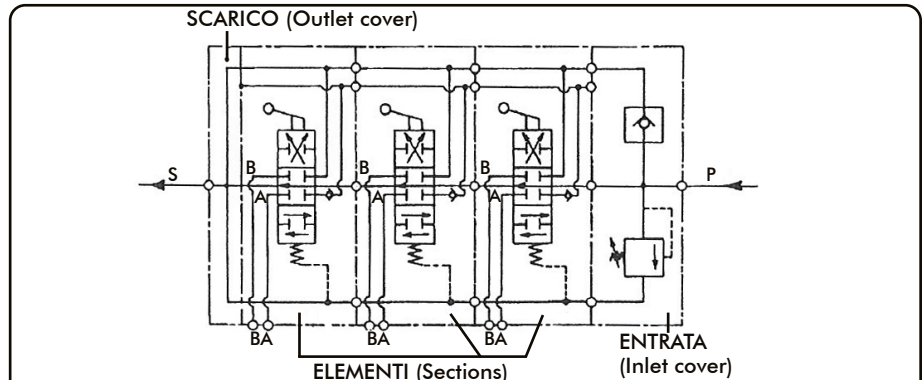
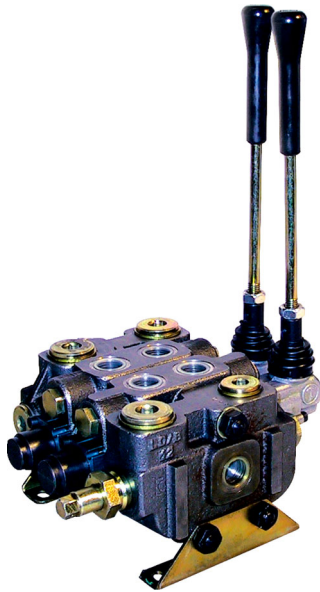







Perdite di carico / Head loss		
Portata Flow lt/min	Completo 1 leva 1 unit complete bar	Solo elemento Section only bar
70	2,2	1,3
62	1,8	1
50	1,3	0,8
37	1	0,3

Testata scarico (outlet cover)
T2, T3, T4
Elementi (sections)
A2, B2, A1, B1
Testata entrata (inlet cover)
T1, P1, V, P
M 10
42, 70, 92, 135, 40, 66, 146, 243, 107, 144, 100, 9x12

243, 107, 144, 100, 9x12

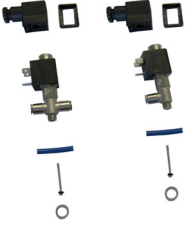
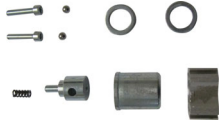
Simbolo / Symbol	Descrizione / Description
P-P1	Pressione - Pressure
A-B	Utilizzi - Service ports
T1-T2-T3-T4	Scarico - Tank outlet
V	Regolazione press. max. Relief valve adjustmet

Tipo Type	Codice Code	Portata Flow l/min	Pressione Pressure bar	Dimensioni Dimension mm		Filettature disponibili Available thread				Peso Weight Kg
				F	G	P-P1	A-B	T	T1-T2-T2-T3-T4	
1 Leva - lever	13401900014	50	250	102,5	140	1/2" BSP	1/2" BSP	3/4" BSP	3/4" BSP	8,7
2 Leve - levers	13401900023			144,5	182					11,8
3 Leve - levers	13401900032			186,5	224					14,9
4 Leve - levers	13401900041			228,5	266					18
5 Leve - levers	13401900050			270,5	308					21,1
6 Leve - levers	13401900069			312,5	350					24,2
7 Leve - levers	13401900078			354,5	392					27,3
8 Leve - levers	13401900087			396,5	434					30,4
9 Leve - levers	13401900096			438,5	476					33,5

	1340200066 Elemento completo singolo <i>Single element assembly</i>
	13402000388 Kit servocomando pneumatico LT40/08-50 <i>Pneumatic servo control kit LT40/08-50</i>
	13401600491 (12V) 13401600508 (24V) Kit elettrovalvole + raccordi per servocomando elettropneumatico 12V e 24V <i>Electropneumatic servo control kit 12V-24V</i>
	13402200108 Kit movimento scatto/scatto LT 40-08/50 <i>Lock/lock kit LT 40-08/50</i>
	13402200162 Kit movimento scatto/molla LT 40-08/50 <i>Lock/spring kit LT 40-08/50</i>
	13402000093 Tappo doppio scarico. <i>Double outlet plug.</i>
	13401600446 Leva nuda + pomello <i>Lever + knob</i>

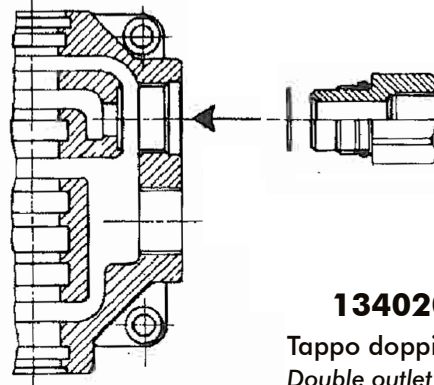

13402000093
Tappo doppio scarico
Double outlet plug

ALTRI ACCESSORI / OTHERS ACCESSORIES

13402000011	Fiancata entrata + valvola sicurezza / <i>Inlet cover+relief valve</i>
13402000084	Fiancata scarico / <i>Outlet cover</i>
13402000119	Mag. valvola 2° antiurto su A e B / <i>Valve</i>
13402000164	Mag. scatti 3 posizioni / <i>3 positions lock</i>
13402000306	Kit tiranti per 1 elemento / <i>Screws kit</i>
13402000315	Kit tiranti per 2 elementi / <i>Screws kit</i>
13402000324	Kit tiranti per 3 elementi / <i>Screws kit</i>
13402000333	Kit tiranti per 4 elementi / <i>Screws kit</i>
13402000342	Kit tiranti per 5 elementi / <i>Screws kit</i>
13402000351	Kit tiranti per 6 elementi / <i>Screws kit</i>
13402000360	Kit tiranti per 7 elementi / <i>Screws kit</i>

DISTRIBUTORI COMPOSTO "LT 40" A 1-2-3-4-5-6-7-8-9-10 LEVE

CODICE FAMIGLIA
FAMILY CODE

134021



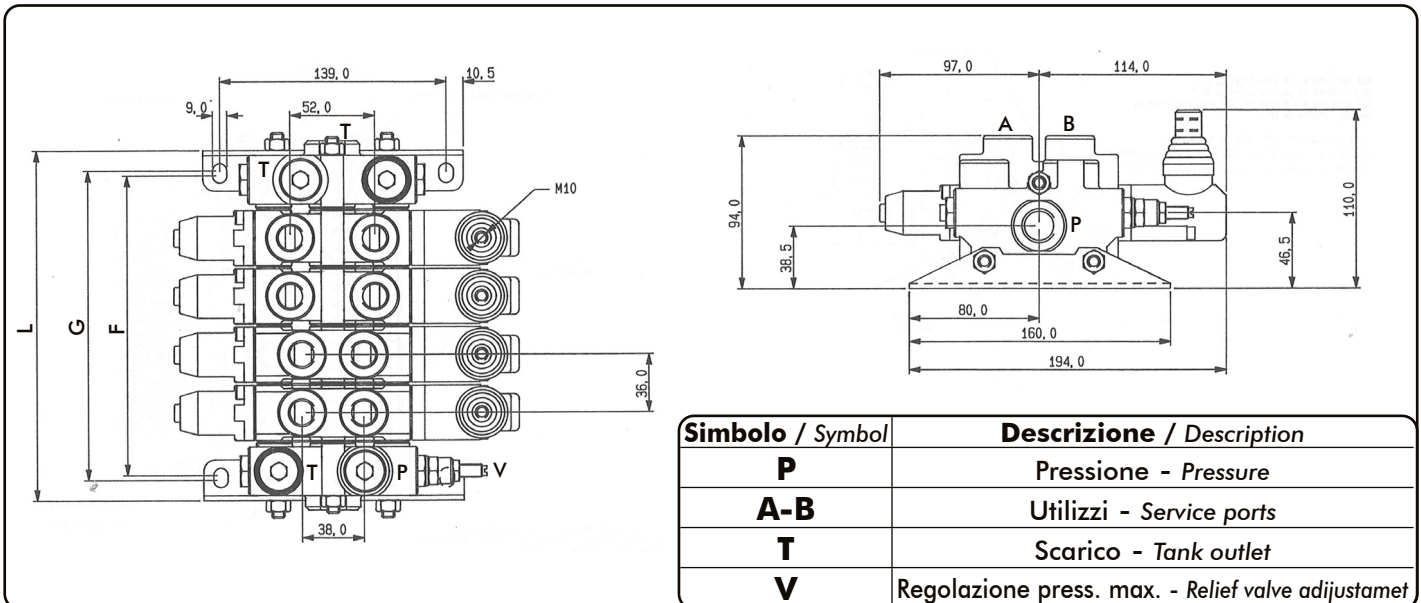
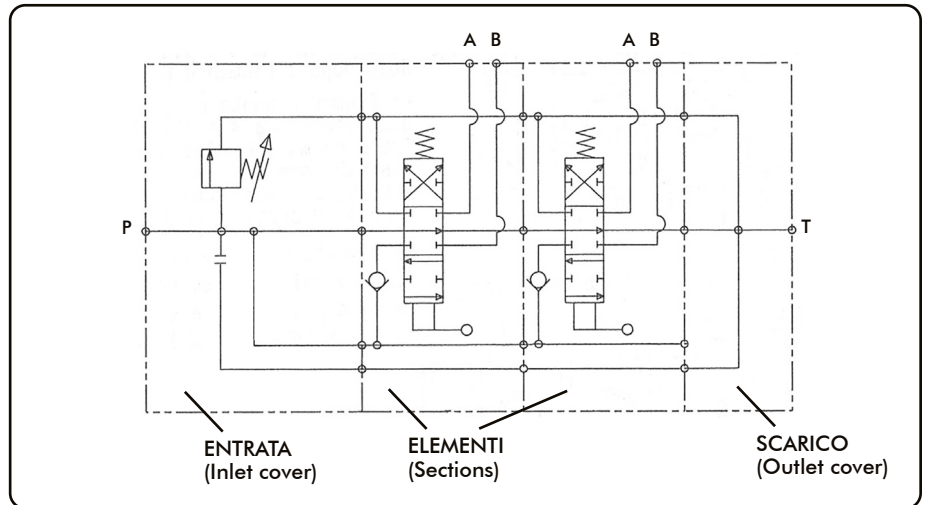
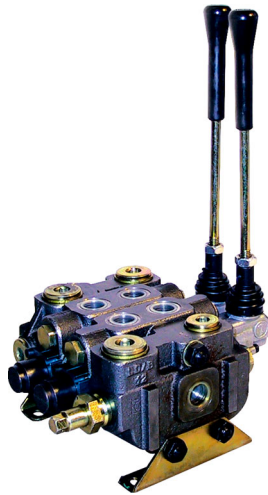

DIRECTIONAL CONTROL VALVES "LT40" WITH 1-2-3-4-5-6-7-8-9-10 LEVERS

LT 40

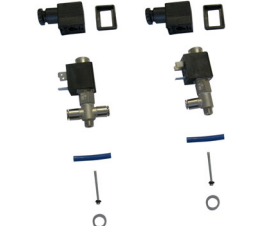

Tipo Type	Codice Code	Portata Flow l/min	Pressione Pressure bar	Dimensioni Dimension mm			Filettature disponibili Available thread				Peso Weight Kg
				F	G	L	P	A	B	T	
1 Leva - lever	13402100010	40	280	77	83	108	1/2" BSP	3/8" BSP	3/8" BSP	1/2" BSP	4,5
2 Leve - levers	13402100029			113	119	144					6
3 Leve - levers	13402100038			149	155	180					7,5
4 Leve - levers	13402100047			185	191	216					9
5 Leve - levers	13402100056			221	227	252					10,5
6 Leve - levers	13402100065			257	263	288					12
7 Leve - levers	13402100074			293	299	324					13,5
8 Leve - levers	13402100083			329	335	360					15
9 Leve - levers	13402100092			365	371	396					16,5
10 Leve - levers	13402100109			401	407	432					18

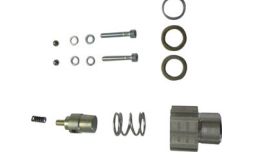
Gli attacchi P e T sono tutti da 1/2" su richiesta si possono avere da 3/8". Connections P and T are all 1/2" BSP 3/8" BSP is available on request.
Gli attacchi A e B sono tutti da 3/8" su richiesta si possono avere da 1/2". Connections A and B are 3/8" BSP 1/2" BSP is available on request.

	<p>13402000388 Kit servocomando pneumatico LT40/08-50 <i>Pneumatic servo control kit LT40/08-50</i></p>
	<p>13401600491 (12V) 13401600508 (24V) Kit elettrovalvole + raccordi per servocomando elettropneumatico 12V e 24V <i>Electropneumatic servo control kit 12V-24V</i></p>
	<p>13402200108 Kit movimento scatto/scatto LT 40-08/50 <i>Lock/lock kit LT 40-08/50</i></p>
	<p>13402200162 Kit movimento scatto/molla LT 40-08/50 <i>Lock/spring kit LT 40-08/50</i></p>
	<p>13402200046 Tappo di conversione. <i>Conversion plug.</i></p>

ALTRI ACCESSORI / OTHERS ACCESSORIES

13402200019	Fiancata entrata + valvola max. / <i>Inlet cover+relief valve</i>
13402200028	Fiancata di scarico / <i>Outlet cover</i>
13402200037	Elemento leva completo parallelo / <i>Lever</i>
13402200304	Kit tiranti per 1 elemento / <i>Screws kit</i>
13402200313	Kit tiranti per 2 elementi / <i>Screws kit</i>
13402200322	Kit tiranti per 3 elementi / <i>Screws kit</i>
13402200331	Kit tiranti per 4 elementi / <i>Screws kit</i>
13402200340	Kit tiranti per 5 elementi / <i>Screws kit</i>
13402200359	Kit tiranti per 6 elementi / <i>Screws kit</i>

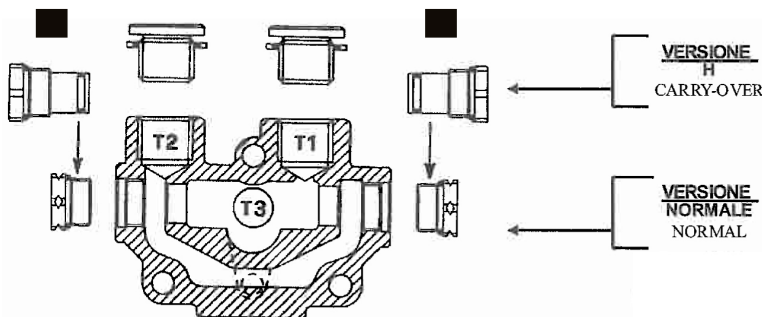

Sezione di fiancata di scarico LT 40/08 tipo CARRY-OVER con uscite T1 e T3 per collegamento in pressione a seguire e uscita T2 da collegare al serbatoio. Chiudere T2 in caso si utilizzi l'attacco sulla testata di entrata. Tutti i tappi raffigurati sono forniti di serie.

Outlet cover LT 40/08 CARRY-OVER type with ports T1 and T3 for pressure connection and port T2 for tank connection. Close T2 when using the tank port on the inlet cover. All the plugs shown are supplied as standard.

SCHEMA MONTAGGIO FIANCATA SCARICO CON TAPPI PER CARRY-OVER. PER OTTENERE IL CENTRO CHIUSO È SUFFICIENTE CHIUDERE L'ATTACCO T3 CON UN TAPPO DA 1/2 BSP

OUTLET COVER WITH SPECIAL PLUGS FOR CARRY-OVER VERSION. TO OBTAIN A CLOSED CLOSED CENTER, SHUT-OFF PORT T3 WITH A 1/2 BSP PLUG.

Trasformazione fiancata scarico normale in tipo H
Instructions for change std outlet cover in carry-out style

13402200046

Tappi di conversione.
Conversion plug.

DISTRIBUTORI COMPOSTO "LT 120"

A 1-2-3-4-5-6-7-8 LEVE

DIRECTIONAL CONTROL VALVES "LT 120"

WITH 1-2-3-4-5-6-7-8 LEVERS

CODICE FAMIGLIA
FAMILY CODE





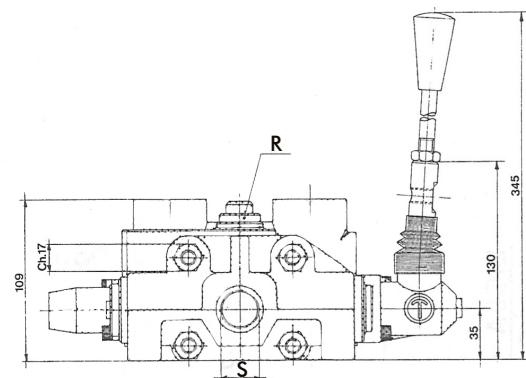
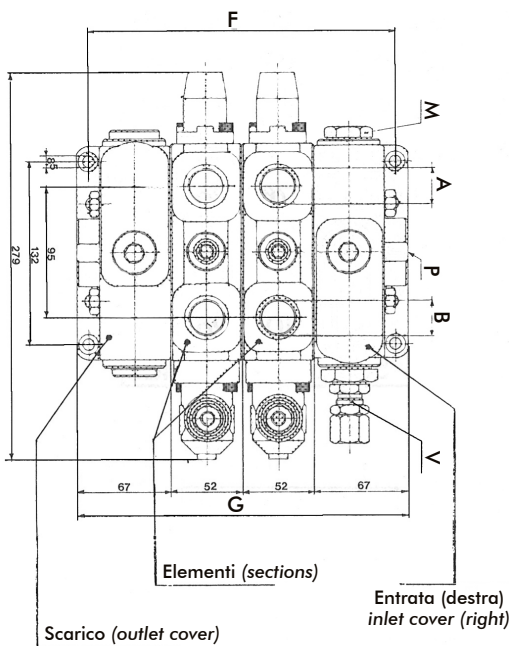
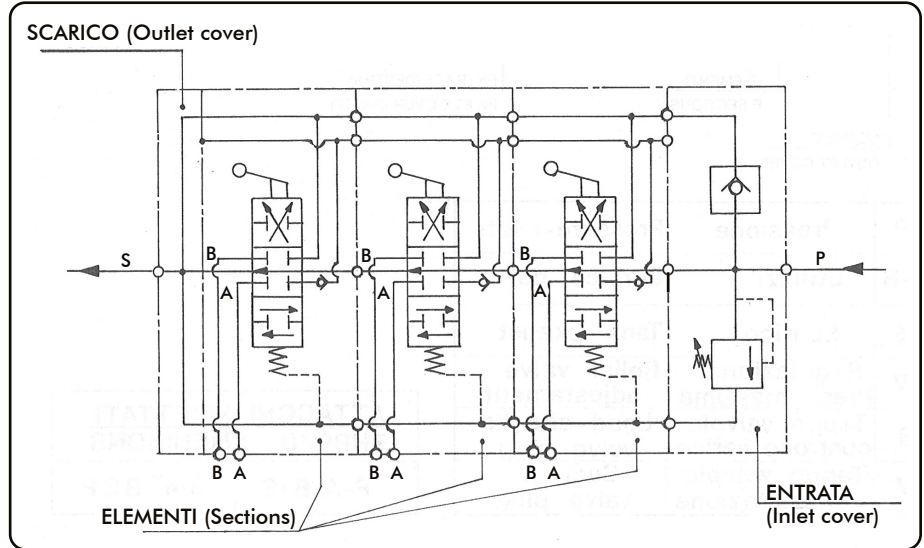

134023

LT 120

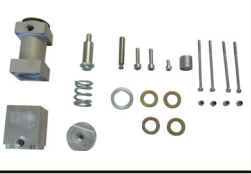
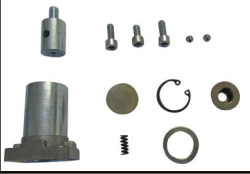
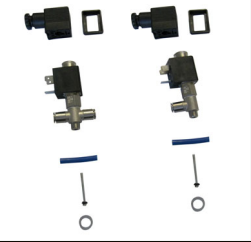
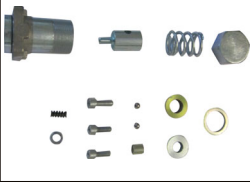
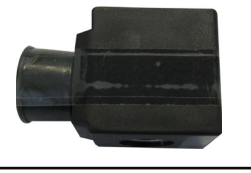
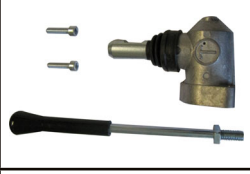

Simbolo / Symbol	Descrizione / Description
P	Pressione - Pressure
A-B	Utilizzi - Service ports
(S) T	Scarico - Tank outlet
R	Tappo vlv. controllo carico - Load control valve plug
M	Tappo vlv. anticavitazione - Suction valve plug
V	Regolazione press. max. - Relief valve adjustmet

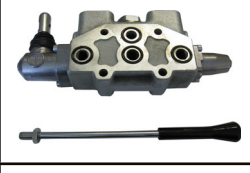
Tipo Type	Codice Code	Portata Flow l/min	Pressione Pressure bar	Dimensioni Dimension mm		Filettature disponibili Available thread P-A-B-T	Peso Weight Kg
				F	G		
1 Leva - lever	13402300018	120	250	168	186	3/4" BSP	13,6
2 Leve - levers	13402300027			220	238		18,8
3 Leve - levers	13402300036			272	290		24
4 Leve - levers	13402300045			324	342		29,2
5 Leve - levers	13402300054			376	394		34,4
6 Leve - levers	13402300063			428	446		39,6
7 Leve - levers	13402300072			480	498		44,8
8 Leve - levers	13402300081			532	550		50

	1340160035 Kit servocomando pneumatico LT 60/120 <i>Pneumatic servo control kit LT 60/120</i>		1340160017 Kit movimento scatto/scatto LT 60/120 <i>Lock/lock kit LT 60/120</i>
	13401600491 (12V) 13401600508 (24V) Kit elettrovalvole + raccordi per servocomando elettropneumatico 12V e 24V <i>Electropneumatic servo control kit 12V-24V</i>		13401600179 Kit movimento scatto/molla LT 60/120 <i>Lock/spring kit LT 60/120</i>
	13401600099 (12V) 13401600106 (24V) Bobina 12V o 24V servocomando <i>Coil</i>		13401600151 Gruppo leva completo <i>Assembly lever group</i>
	13401600197 Kit servocomando elettroidraulico 24V <i>Electrohydraulic 24V kit</i>		13401600446 Leva nuda + pomello <i>Lever + knob</i>
	13401600517 Kit servocomando elettroidraulico 12V <i>Electrohydraulic 12V kit</i>		13402400035 Elemento completo singolo <i>Single element</i>
	13401600204 Valvola contropressione scarico servocomando elettroidraulico <i>Back-pressure valves</i>		13402400044 Fiancata scarico <i>Outlet cover</i>
			13402400053 Fiancata entrata + valvola sicu- rezza <i>Inlet cover+relief valve</i>

ALTRI ACCESSORI / OTHERS ACCESSORIES

- 13402400302** Kit tiranti per 1 elemento/Screws kit
- 13402400311** Kit tiranti per 2 elementi/Screws kit
- 13402400320** Kit tiranti per 3 elementi/Screws kit
- 13402400339** Kit tiranti per 4 elementi/Screws kit
- 13402400348** Kit tiranti per 5 elementi/Screws kit
- 13402400357** Kit tiranti per 6 elementi/Screws kit

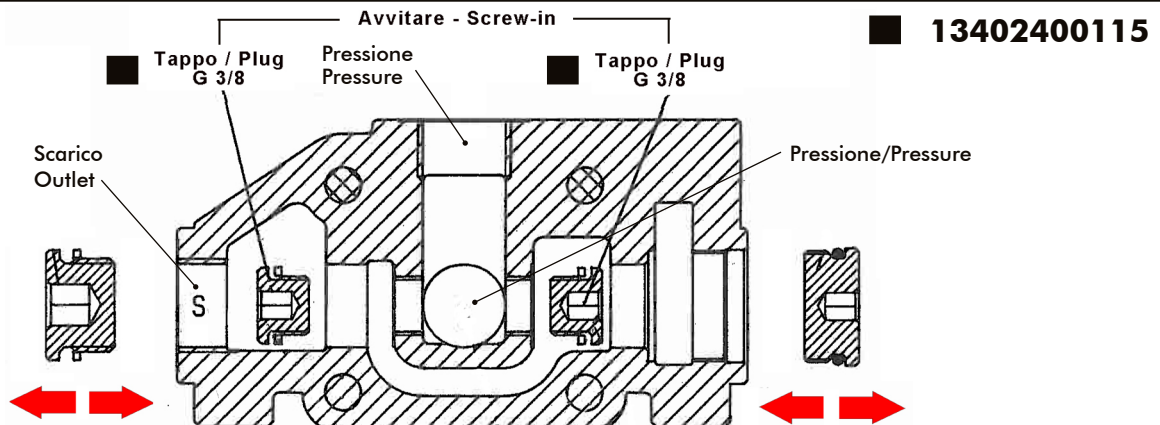

Trasformazione fiancata scarico normale in tipo H
Instructions for change std outlet cover in carry-out style

SCHEMI DEI CURSORI DISPONIBILI LAYOUTS OF AVAILABLE PILOT SHAFTS

SIGLA CODE	SCHEMA LAYOUT	CARATTERISTICHE FEATURES
A		Cursore a centro aperto (P→S) in posizione centrale. Utilizzi chiusi. A leva spinta P→A, B→S. A leva tirata P→B, A→S. <i>Centre pilot shaft open (P→S) in central position. Service ports closed. With lever pushed P→A, B→S. With lever pulled P→B, A→S.</i>
C		Cursore a centro aperto (P→S) in posizione centrale. Utilizzi allo scarico. A leva spinta P→A, B→S. A leva tirata P→B, A→S. <i>Centre pilot shaft open (P→S) in central position. Service ports in discharge. With lever pushed P→A, B→S. With lever pulled P→B, A→S.</i>
D		Cursore a centro chiuso (P→) in posizione centrale. Utilizzi chiusi. A leva spinta P→A, B→S. A leva tirata P→B, A→S. Ottenibile anche montando sullo scarico il tappo D. <i>Centre pilot shaft closed (P→) in central position. Service ports closed. With lever pushed P→A, B→S. With lever pulled P→B, A→S. Also obtainable by mounting plug D on outlet.</i>
B		Cursore a centro aperto (P→S) in posizione centrale. Utilizzo B chiuso, utilizzo A allo scarico. A leva spinta P→S, B→S. A leva tirata P→B, A→S. <i>Centre pilot shaft open (P→S) in central position. Service port B closed, service port A in discharge. With lever pushed P→S, B→S. With lever pulled P→B, A→S.</i>
E		Cursore a centro aperto (P→S) in posizione centrale per cilindri a semplice effetto. Utilizzo chiuso. A leva spinta P→B→S. A leva tirata P→B. <i>Centre pilot shaft open (P→S) in central position for single-acting cylinders. Service port closed. With lever pushed P→B→S. With lever pulled P→B.</i>
F		Cursore a centro aperto (P→S) in posizione centrale per cilindri a semplice effetto. Utilizzo chiuso. A leva spinta P→A. A leva tirata P→A→S. <i>Centre pilot shaft open (P→S) in central position for single-acting cylinders. Service port closed. With lever pushed P→A. With lever pulled P→A→S.</i>
G		Cursore a centro aperto (P→S) in posizione centrale. Utilizzi chiusi. Per cilindri a doppio effetto con IV posizione flottante. A leva spinta P→A, B→S, a leva ulteriormente spinta A-B→S con aggancio di ritenuta. A leva tirata P→B, A→S. <i>Centre pilot shaft open (P→S) in central position. Service ports closed. For double-acting cylinders with 4th pos. floating. With lever pushed further A-B→S with engage. With lever pulled P→B, A→S.</i>
I		Cursore a centro aperto (P→S) in posizione centrale. Utilizzo A chiuso. Utilizzo B a scarico. A leva spinta P→A, B→S. A leva tirata P→B, A→S. <i>Centre pilot shaft open (P→S) in central position. Service port A closed. Service port B in discharge. With lever pushed P→A, B→S. With lever pulled P→B, A→S.</i>
M		Cursore a centro chiuso in posizione centrale. Utilizzi allo scarico. A leva spinta P→A, B→S. A leva tirata P→B, A→S. Ottenibile anche montando sullo scarico il tappo D con cursore tipo C. <i>Centre pilot shaft closed in central position. Service ports in discharge. With lever pushed P→A, B→S. With lever pulled P→B, A→S. Also obtainable by mounting plug D on outlet with type C pilot.</i>
N		Cursore a centro chiuso. In posizione centrale utilizzo B allo scarico. Utilizzo A chiuso. A leva spinta P→A, B→S. A leva tirata P→B, A→S. Ottenibile anche montando sullo scarico il tappo D con cursore tipo C. <i>Centre pilot shaft closed in central position. Service port B in discharge. Service port A closed. With lever pushed P→A, B→S. With lever pulled P→B, A→S. Also obtainable by mounting plug D on outlet with type C pilot.</i>
O		Cursore a centro chiuso. In posizione centrale utilizzo A allo scarico. Utilizzo B chiuso. A leva spinta P→A, B→S. A leva tirata P→B, A→S. Ottenibile anche montando sullo scarico il tappo D con cursore tipo C. <i>Centre pilot shaft closed in central position. Service port A in discharge. Service port B closed. With lever pushed P→A, B→S. With lever pulled P→B, A→S. Also obtainable by mounting plug D on outlet with type C pilot.</i>
P		Cursore a centro aperto per cilindri a semplice effetto o motori unidirezionali, in posizione centrale utilizzo B a scarico. A leva tirata P→B. <i>Centre pilot shaft open in central position for single-acting cylinders or unidirectional motors. Service port B in discharge, with lever pulled P→B.</i>
Q		Cursore a centro aperto per cilindri a semplice effetto o motori unidirezionali, in posizione centrale utilizzo A a scarico. A leva tirata P→A. <i>Centre pilot shaft open in central position for single-acting cylinders or unidirectional motors. Service port A in discharge, with lever pulled P→A.</i>

SCHEMI DEI TIPI DI AZIONAMENTO DIAGRAMS OF OPERATION TYPES

SIGLA CODE	SCHEMA LAYOUT	CARATTERISTICHE FEATURES
13R2		Posizione 2: stabile. Posizioni 1-3: ritorno molla in posizione 2. Position 2: stable. Positions 1-3: spring return in position 2.
1R3		Posizione 3: stabile. Leva normalmente rientrata, tirando la leva vado in posizione 1. Transient aperto=213-C - Transitorio chiuso=213-D Position 3: stable. Lever normally pushed in. Pull lever to go in position 1. Transient open=213-C - Transien closed=213-D
1R2		Posizione 2: stabile. Tirando la leva vado in posizione 1. Rilasciando torna in posizione 2. Position 2: stable. Pull lever to go to position 1. Release to return to position 2.
3R2		Posizione 2: stabile. Spingendo la leva vado in posizione 3. Rilasciando torna in posizione 2. Position 2: stable. Push lever to go to position 3. Release to return to position 2.
3R1BC/BD		Posizione 1: stabile. Leva normalmente fuori. Spingendo la leva vado in posizione 3. Transient aperto=213/B-C - Transitorio chiuso=213/B-D Position 1: stable. Lever normally pulled out. Push lever to go to position 3. Transient open=213/B-C - Transien closed=213/B-C
2R1		Posizione 1: stabile. Leva normalmente fuori. Spingendo la leva vado in posizione 2. Rilasciando torna in posizione 1. Position 1: stable. Lever normally pulled out. Push the lever to go to position 2. Release to return to position 1.
2R3		Posizione 3: stabile. Leva normalmente dentro. Tirando la leva vado in posizione 2. Rilasciando torna in posizione 3. Position 3: stable. Lever normally pushed in. Pull lever to go to position 2. Release to return to position 3.
123		Ritenuta a scatti nelle 3 posizioni. Three position locking.
13CD		Ritenuta a scatti nelle posizioni estreme. Transitorio aperto=4C. Transitorio chiuso=4D. Locked in last position. Transien open=4C. Transien closed=4D.
23		Ritenuta a scatti nelle posizioni 2-3 posizione centrale e la leva spinta stabili. Locked in positions 2-3. Lever pushed in and central position stable.
12		Ritenuta a scatti nelle posizioni 1-2 posizione centrale e a leva tirata stabili. Locked in positions 1-2. Lever pulled and central position stable.
3S1R2		Ritenuta a scatti in posizione 3 a leva spinta. Posizione centrale 2 stabile. Posizione 1 con leva tirata con ritorno a molla in posizione 2. Locked in position 3 with lever pushed in. Central position 2 stable. Position 1 with lever pulled and spring return to position 2.
13R2P		Azionamento con servocomando pneumatico posizione 2 stabile. Posizioni estreme 1-3 con ritorno al centro. Operation with pneumatic servo-control. Position 2 stable. End positions 1-3 with return to center.
1234		Ritenuta a scatti nelle 4 posizioni. E' possibile solo con cursore tipo G. Locked in 4 positions. Only possible with type G pilot shaft.
13R20		Azionamento con servocomando oleodinamico. Posizione 2 stabile. Posizioni 1-3 con ritorno a molla in posizione 2 (senza leva di azionamento). Operation with hydraulic servo-control. Position 2 stable. Positions 1-3 with spring return to position 2 (without control lever).
1S3R2		Ritenuta a scatti in posizione 1 a leva tirata. Posizione centrale 2 stabile. Posizione 3 a leva spinta con ritorno a molla al centro. Locked in position 1 with lever pulled. Central position 2 stable. Position 3 with lever pushed and spring return to center.

Алматы (7273)495-231
Ангарск (3955)60-70-56
Архангельск (8182)63-90-72
Астрахань (8512)99-46-04
Барнаул (3852)73-04-60
Белгород (4722)40-23-64
Благовещенск (4162)22-76-07
Брянск (4832)59-03-52
Владивосток (423)249-28-31
Владикавказ (8672)28-90-48
Владимир (4922)49-43-18
Волгоград (844)278-03-48
Вологда (8172)26-41-59
Воронеж (473)204-51-73
Екатеринбург (343)384-55-89

Иваново (4932)77-34-06
Ижевск (3412)26-03-58
Иркутск (395)279-98-46
Казань (843)206-01-48
Калининград (4012)72-03-81
Калуга (4842)92-23-67
Кемерово (3842)65-04-62
Киров (8332)68-02-04
Коломна (4966)23-41-49
Кострома (4942)77-07-48
Краснодар (861)203-40-90
Красноярск (391)204-63-61
Курск (4712)77-13-04
Курган (3522)50-90-47
Липецк (4742)52-20-81

Магнитогорск (3519)55-03-13
Москва (495)268-04-70
Мурманск (8152)59-64-93
Набережные Челны (8552)20-53-41
Нижний Новгород (831)429-08-12
Новокузнецк (3843)20-46-81
Ноябрьск (3496)41-32-12
Новосибирск (383)227-86-73
Омск (3812)21-46-40
Орел (4862)44-53-42
Оренбург (3532)37-68-04
Пенза (8412)22-31-16
Петрозаводск (8142)55-98-37
Пермь (342)205-81-47

Ростов-на-Дону (863)308-18-15
Рязань (4912)46-61-64
Самара (846)206-03-16
Санкт-Петербург (812)309-46-40
Саратов (845)249-38-78
Севастополь (8692)22-31-93
Саранск (8342)22-96-24
Симферополь (3652)67-13-56
Смоленск (4812)29-41-54
Сочи (862)225-72-31
Ставрополь (8652)20-65-13
Сургут (3462)77-98-35
Сыктывкар (8212)25-95-17
Тамбов (4752)50-40-97
Тверь (4822)63-31-35

Тольятти (8482)63-91-07
Томск (3822)98-41-53
Тула (4872)33-79-87
Тюмень (3452)66-21-18
Ульяновск (8422)24-23-59
Улан-Удэ (3012)59-97-51
Уфа (347)229-48-12
Хабаровск (4212)92-98-04
Чебоксары (8352)28-53-07
Челябинск (351)202-03-61
Череповец (8202)49-02-64
Чита (3022)38-34-83
Якутск (4112)23-90-97
Ярославль (4852)69-52-93

Россия +7(495)268-04-70

Казахстан +7(7172)727-132

Киргизия +996(312)96-26-47